

This article was downloaded by:

On: 23 January 2011

Access details: *Access Details: Free Access*

Publisher *Taylor & Francis*

Informa Ltd Registered in England and Wales Registered Number: 1072954 Registered office: Mortimer House, 37-41 Mortimer Street, London W1T 3JH, UK



Journal of Coordination Chemistry

Publication details, including instructions for authors and subscription information:

<http://www.informaworld.com/smpp/title~content=t713455674>

NMR INVESTIGATION OF NICKEL(II) AND COBALT(II) BONDING: FURTHER EVIDENCE FOR COORDINATION OF HYDROXY AND ETHEREAL OXYGEN ATOMS IN AQUEOUS SOLUTION

D. S. Everhart^a; M. M. McKown^a; R. F. Evilia^a

^a Department of Chemistry, University of New Orleans, New Orleans, Louisiana

To cite this Article Everhart, D. S. , McKown, M. M. and Evilia, R. F.(1979) 'NMR INVESTIGATION OF NICKEL(II) AND COBALT(II) BONDING: FURTHER EVIDENCE FOR COORDINATION OF HYDROXY AND ETHEREAL OXYGEN ATOMS IN AQUEOUS SOLUTION', *Journal of Coordination Chemistry*, 9: 3, 185 – 195

To link to this Article: DOI: 10.1080/00958977908076526

URL: <http://dx.doi.org/10.1080/00958977908076526>

PLEASE SCROLL DOWN FOR ARTICLE

Full terms and conditions of use: <http://www.informaworld.com/terms-and-conditions-of-access.pdf>

This article may be used for research, teaching and private study purposes. Any substantial or systematic reproduction, re-distribution, re-selling, loan or sub-licensing, systematic supply or distribution in any form to anyone is expressly forbidden.

The publisher does not give any warranty express or implied or make any representation that the contents will be complete or accurate or up to date. The accuracy of any instructions, formulae and drug doses should be independently verified with primary sources. The publisher shall not be liable for any loss, actions, claims, proceedings, demand or costs or damages whatsoever or howsoever caused arising directly or indirectly in connection with or arising out of the use of this material.

NMR INVESTIGATION OF NICKEL(II) AND COBALT(II) BONDING: FURTHER EVIDENCE FOR COORDINATION OF HYDROXY AND ETHEREAL OXYGEN ATOMS IN AQUEOUS SOLUTION

D. S. EVERHART, M. M. McKOWN and R. F. EVILIA*

Department of Chemistry, University of New Orleans, New Orleans, Louisiana 70122

(Received August 1, 1977; in final form January 11, 1979)

The proton magnetic resonance spectra of a variety of nickel (II) and cobalt (II) complexes are reported. The spectra are interpreted to indicate a substantial amount of coordination by hydroxy and ethereal oxygens in all cases. Analysis of the spectral temperature dependence indicates that ΔH for coordination of oxygen is very nearly zero in all but one nickel case. The driving force for coordination of these oxygens appears to be a gain in entropy. It was not possible to quantitatively measure the amount of coordination in the cobalt complexes.

The ligands reported are: Methoxyethyliminodiacetic acid (MEIDA = $\text{CH}_3\text{OCH}_2\text{CH}_2\text{N}(\text{CH}_2\text{CO}_2)_2$), Hydroxyethyliminodiacetic acid (HEIDA = $\text{HOCH}_2\text{CH}_2\text{N}(\text{CH}_2\text{CO}_2)_2$), Serine (SER = $\text{NH}_2\text{CH}(\text{CH}_2\text{OH})\text{CO}_2\text{H}$), 2(2-aminoethyl amino) ethanol (AEAE = $\text{NH}_2\text{CH}_2-\text{CH}_2\text{NHCH}_2\text{CH}_2\text{OH}$), N,N'-Bis-(2-Hydroxyethyl)ethylenediamine (BHEEN = $\text{HOCH}_2\text{CH}_2-\text{NHCH}_2\text{CH}_2\text{NHCH}_2\text{CH}_2\text{OH}$). In all cases equilibration between coordinated and uncoordinated oxygens was rapid. The fraction of time that the oxygen is coordinated at 34°C was found to be $0.85 \pm .18$, $0.75 \pm .17$, $0.57 \pm .18$, and $0.62 \pm .25$ for the nickel (II) complexes of MEIDA, HEIDA, SER, AEAE, and BHEEN respectively. ΔH was 0 in all cases except SER and BHEEN in which ΔH was -800 cal/mole and $+1400$ cal/mole respectively. The positive ΔH for coordination of BHEEN oxygens was assigned to ring strain as ΔH for oxygen coordination appears to be zero. The ring strain is found to be approximately 2.7 kcal/mole.

The rapid exchange of cobalt (II) coordinated SER and uncoordinated SER is interpreted to indicate that the hydroxy oxygen is uncoordinated a substantial amount of time in the complex $\text{Co}(\text{SER})_2$, and that attack of an uncoordinated serine NH_2 at the vacant (water occupied) site is the rate determining step in the reaction.

INTRODUCTION

Alcoholic and ethereal oxygens have been shown to coordinate to nickel (II) and cobalt (II) under certain conditions.¹⁻⁹ On the other hand there have also been reports of the failure of such oxygen atoms to form stable bonds under conditions where coordination might reasonably be expected.^{10,11} In much of the earlier work oxygen coordination was observed in non-coordinating solvents,^{2,5-9} with only a few reports of oxygen coordination in aqueous solution.^{1,3,4,10} In view of the relatively few studies of this area and the general lack of reactivity of crown ethers toward transition metals, one is tempted to treat the cases of observed oxygen coordination as a rare and unusual property which occurs only in a few scattered cases.

In this paper, evidence is presented that ethereal and alcoholic oxygen atoms can successfully compete with water for metal coordination sites if the ligand contains other suitably strong coordinating groups

that insure the overall stability of the complex. The results reported here indicate that the ΔH for replacement of a coordinated water by a R-OH or R-O-R is, not surprisingly, very nearly zero in most cases. The procedure used to determine whether or not a particular oxygen is coordinated to nickel (II) was similar to that previously reported,³ that is, the contact shift induced at protons adjacent to the oxygen in question were used as a probe of the bonding. In the case of cobalt (II) coordination, the presence of pseudo contact shifts complicates the interpretation, but, as shown below, the spectra can be qualitatively interpreted in terms of the bonding though quantitative evaluation was not possible.

EXPERIMENTAL

All nmr spectra were obtained on a Hitachi R20B spectrometer equipped with a Hewlett Packard 240B power amplifier and R202VT variable temperature

accessory as previously described.^{1,2} All chemicals used were of the highest commercial purity available except for MEIDA which was synthesized by carboxymethylation of methoxyethyl amine according to the procedures of Smith *et al.*^{1,3}

Nickel (II) complexes were formed by mixing the appropriate mole ratio of nickel (II) chloride solution and the ligand. Sufficient sodium hydroxide to neutralize the carboxylic acids was then added and the water was removed with a rotary evaporator. The complex was then dissolved in deuterium oxide and redried. This process was repeated several times in order to decrease the residual water resonance signal. Cobalt (II) complexes were made in a similar fashion except the base was not added until after removal of water. After removal of water, sodium deuterioxide was added under nitrogen and the

complex was quickly transferred to an nmr tube which was flushed with nitrogen from a capillary tube inserted in the nmr tube. These complexes are not readily oxidized by molecular oxygen, so extreme care in handling is not necessary. The acetate protons of MEIDA and HEIDA were exchanged for deuterium by refluxing a solution of the free ligand in $\sim 0.1 M$ NaOD overnight.

RESULTS

The proton magnetic resonance spectra at 34°C and at high temperatures of some of the complexes investigated are shown in Figures 1, 3, and 5. Figure 2 shows the low temperature spectrum ($-20^\circ C$) of $Ni(MEIDA)(H_2O)_2$. The effect of a large excess of

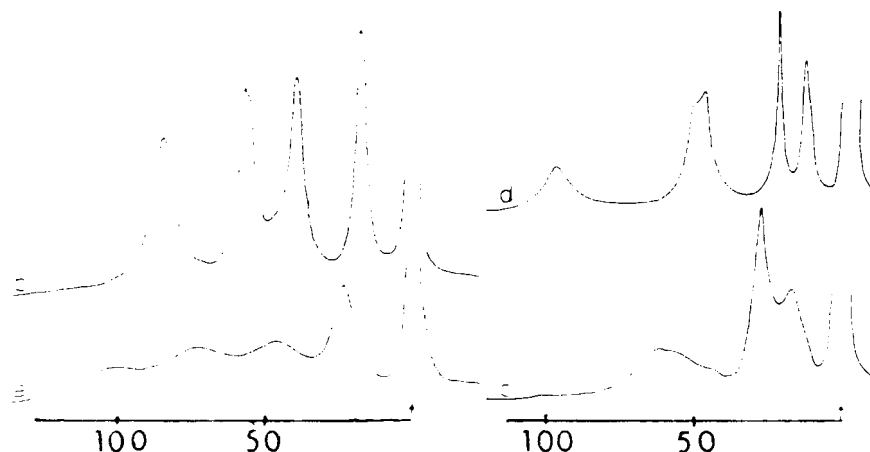

FIGURE 1 Spectra of Nickel(II) complexes of HEIDA, MEIDA

a. $Ni(HEIDA)(H_2O)_2$, $34^\circ C$ b. $Ni(HEIDA)(H_2O)_2$, $96^\circ C$

c. $Ni(MEIDA)(H_2O)_2$, $34^\circ C$ d. $Ni(MEIDA)(H_2O)_2$, $96^\circ C$

The arrow points to the residual HOD peak which is assigned a shift value of zero; the scale is in ppm.

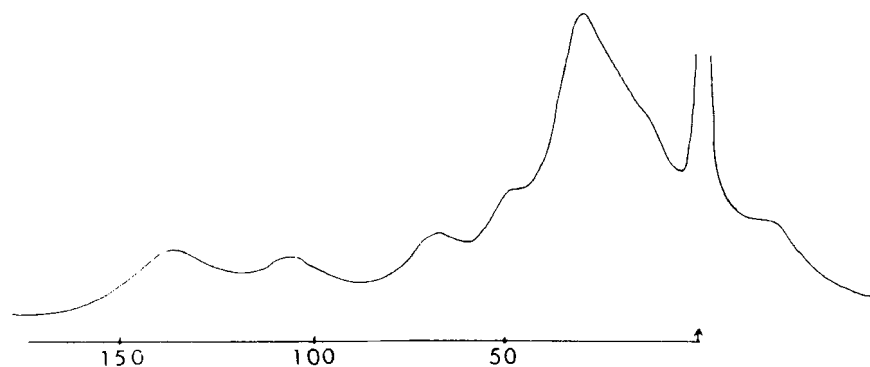

FIGURE 2 Low temperature spectrum of $Ni(MEIDA)(H_2O)_2$ Solvent - 50% D_2O , 50% CD_3OD , $-20^\circ C$. The scale is in ppm.

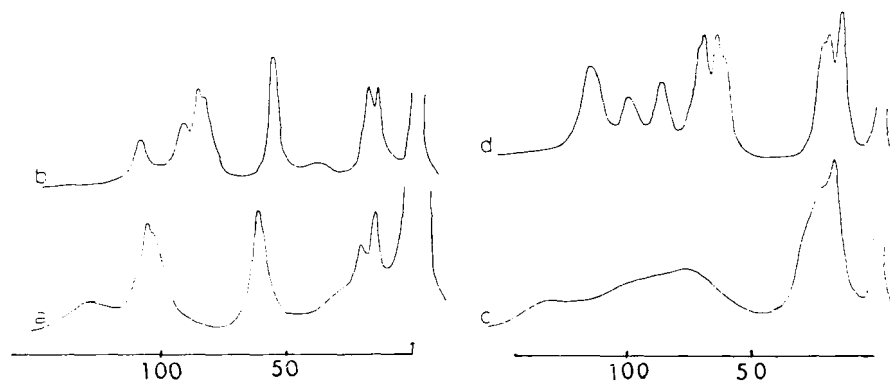

FIGURE 3 Spectra of Nickel(II) Complexes of AEAE and BHEEN
a. $\text{Ni}(\text{AEAE})(\text{H}_2\text{O})_3^{2+}$, 34°C *b.* $\text{Ni}(\text{AEAE})(\text{H}_2\text{O})_3^{2+}$, 96°C
c. $\text{Ni}(\text{BHEEN})(\text{H}_2\text{O})_3^{2+}$, 34°C *d.* $\text{Ni}(\text{BHEEN})(\text{H}_2\text{O})_3^{2+}$, 96°C
 The arrow points to the residual HOD peak which is assigned a shift value of zero; the scale is in ppm.

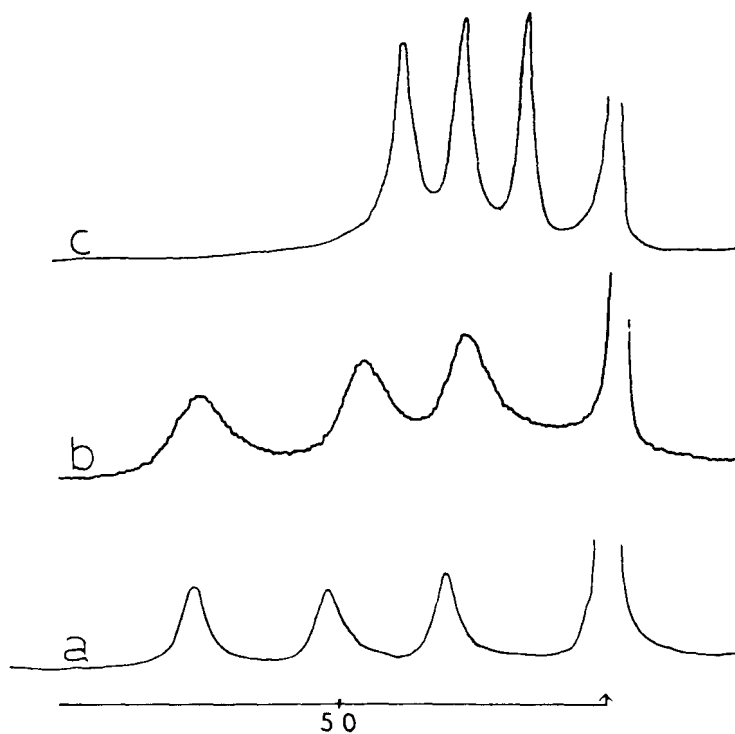

FIGURE 4 Spectra of various cobalt: Serine mole ratios *a.* Co:SER = 1:1, *b.* Co:SER = 1:2, *c.* Co:SER = 1:5.
 Arrow points to residual HOD; the scale is in ppm.

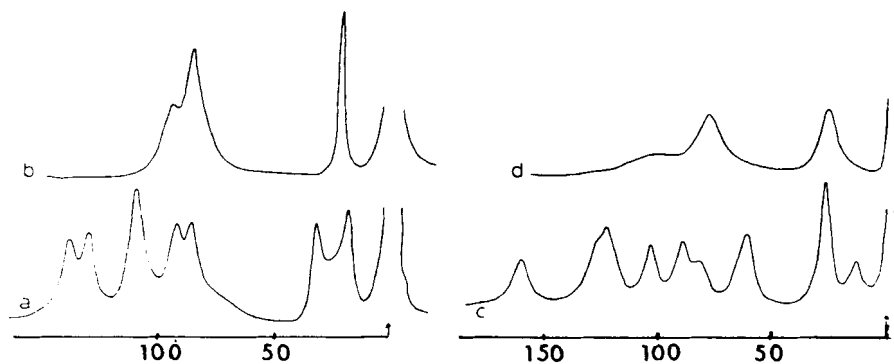

FIGURE 5 Spectra of Cobalt(II) complexes of HEAE and BHEEN *a.* $\text{Co}(\text{AEAE})(\text{H}_2\text{O})_2^{2+}$, 34°C , *b.* $\text{Co}(\text{AEAE})(\text{H}_2\text{O})_2^{2+}$, 96°C , *c.* $\text{Co}(\text{BHEEN})(\text{H}_2\text{O})_2^{2+}$, 34°C , *d.* $\text{Co}(\text{BHEEN})(\text{H}_2\text{O})_2^{2+}$, 96°C . Arrow points to residual HOD; the scale is in ppm.

ligand on the spectral behaviour of the cobalt serine complex is shown in Figure 4. The shift positions and assignments, where known, are tabulated in Table 1 for nickel complexes and Table 3 for cobalt complexes. Upon deuteration of the acetate protons of MEIDA the resonance at -61 ppm disappears in Ni(MEIDA). Deuteration of the acetate protons of HEIDA results in the disappearance of the resonances

at -47 ppm and -74 ppm in Ni(HEIDA) and at -8 ppm and -61 ppm for Co(HEIDA).

DISCUSSION

Nickel (II)

In order to interpret these spectra on the basis of bonding by oxygen atoms it is necessary to decide how the spectrum of an oxygen coordinated species will differ from the spectrum of the same species under conditions where oxygen coordination does not occur. In the case of nickel (II), where pseudo contact shifts are expected to be negligible, one can reasonably expect the protons adjacent to an oxygen to have much greater shifts when the oxygen is coordinated than when it is not coordinated. Cobalt (II) complexes, however, are known to have substantial pseudo contact shifts which make a simple interpretation based only on shift position impossible. Thus, in order to interpret the cobalt (II) data, it will be necessary to consider more subtle consequences of bonding.

Examination of the spectra shown for the various nickel (II) complexes indicates substantial contact shifts for all protons, indicative of oxygen coordination in all cases studied. The MEIDA complex is most interesting and informative in this regard: because of the great distance of the methoxy group from the coordinated nitrogen, the shift expected when the oxygen is uncoordinated, is very small (~ 0). Thus, the appearance of a substantial shift for this methyl group (15 ppm) is very clear evidence for coordination by the oxygen. It is also interesting, however, to note the change in appearance of the spectrum as the temperature is increased — Figure 1. Basically, as the

TABLE I
Spectral assignments of nickel complexes

Complex ^a	Resonance Position ^b	Assignment
Ni(MEIDA)(H ₂ O) ₂	15	CH ₃ -O
	27	CH ₂ -O
	61	CH ₂ CO ₂
	118 ^c	NCH ₂
Ni(HEIDA)(H ₂ O) ₂	23	CH ₂ OH
	47	2CH ₂ CO ₂
	100	NCH ₂
Ni(SER)(H ₂ O) ₃	15	1 CH ₂ OH
	31	1 CH ₂ OH
	34	CHCO ₂ H
Ni(AEAE)(H ₂ O) ₂ ²⁺	16	1 CH ₂ OH
	22	1 CH ₂ OH
	61	2 NCH ₂ CH ₂ N
	96 ^c	1 NCH ₂ CH ₂ OH
	100 ^c	1 NCH ₂ CH ₂ OH
	107 ^c	1 NCH ₂ CH ₂ N
Ni(BHEEN)(H ₂ O) ₂ ²⁺	128 ^c	1 NCH ₂ CH ₂ N
	17	2 CH ₂ OH
	20	2 CH ₂ OH

Other Positions and Assignments Uncertain

^aNumber of waters in structure determined on the basis that all ligand coordinating groups are utilized.

^bppm downfield of water at 34°C .

^cPeak location determined at 96°C and extrapolated to 34°C .

temperature is increased the peak width of the resonances at -15 ppm, -27 ppm, and -61 ppm decrease slightly while the width of the resonance at -118 ppm decreased dramatically. Since the peak which disappears upon deuteration of the acetates is the one at -61 ppm, this resonance, which is greatly affected by temperature, is not due to acetate protons. We have assigned this resonance to the $N-CH_2$ group of the methoxy ethyl on the basis that these protons, adjacent to a coordinated nitrogen, should have a larger contact shift than the CH_3OCH_2 protons which would be adjacent to a coordinated oxygen.³ The temperature dependence is typical of molecules undergoing some kinetic process at a rate comparable to the difference between the resonance frequencies of the nuclei in the two environments between which they are exchanging. As usually occurs in studies of this type, the "frozen" chemical shift values for these two environments is not known. The low temperature spectrum, Figure 2, shows the appearance of new peaks as the kinetic process is slowed but, due to peak broadening and sample freezing, it is not possible to assign the low temperature spectrum. It has previously been shown,³ however, that NCH_2 protons of *N*-methylethanol amine nickel (II) (NiNMEA) have a chemical shift difference of ~ 95 ppm. Because conformational interchange does not result in averaging of the chemical shift differences. Assuming that a similar "frozen" chemical shift difference occurs in this case, the rate of the kinetic process can be estimated to be $\geq 3.6 \times 10^4$ sec⁻¹. The next question which naturally arises, is what is the nature of the kinetic process? The most obvious and reasonable explanation seems to be that this process is the rapid 4-coordinate \rightleftharpoons 3 coordinate equilibrium shown in Scheme I.

The calculation referred to above indicates that the lifetime of either of these forms is $\leq 3 \times 10^{-5}$ sec, but it does not tell how much of each form exists in solution. In order to estimate the position of this equilibrium the following procedure is used. It is assumed that the $N-CH_2$ group of MEIDA will have the same shift as the $N-CH_2$ of *N*-ethyl iminodiacetic acid when the oxygen is uncoordinated (61 ppm) (Structure A, Scheme I) and the same as the NCH_2 group of OMEA ($CH_3OCH_2CH_2NH_2$) when the oxygen is coordinated (120 ppm)^{3,14} (Structure B, Scheme I). The observed shift of 118 ppm is then assumed to be the average of these two shifts weighted by the fraction of time each structure exists in solution. This analysis leads to the following equation:

$$\delta = f\delta_{\text{OMEA}} + (1 - f)\delta_{\text{NEIDA}} \quad (1)$$

where δ = average shift observed
 δ_{OMEA} = shift of similar protons in Ni(OMEA)
 δ_{NEIDA} = shift of similar protons in Ni(NEIDA)
 f = fraction of time that the CH_3-O is coordinated.

Because there are three different types of protons which can be used to calculate f , the assumptions and assignments can be tested for internal consistency. The room temperature spectrum of Ni(MEIDA) appears to indicate that the CH_3O - resonance is at -27 ppm based upon the area of this peak. Integration, by planimeter, of the high temperature spectrum, however, is ambiguous. The peaks at -15 and -27 have, within experimental error, the same area (approximately $3/2$ times the area of the -118 ppm peak). Thus, the assignment of these peaks at 34°C is not certain. This problem in area measurement and apparent inconsistency is very common in measurements of this type and probably results from

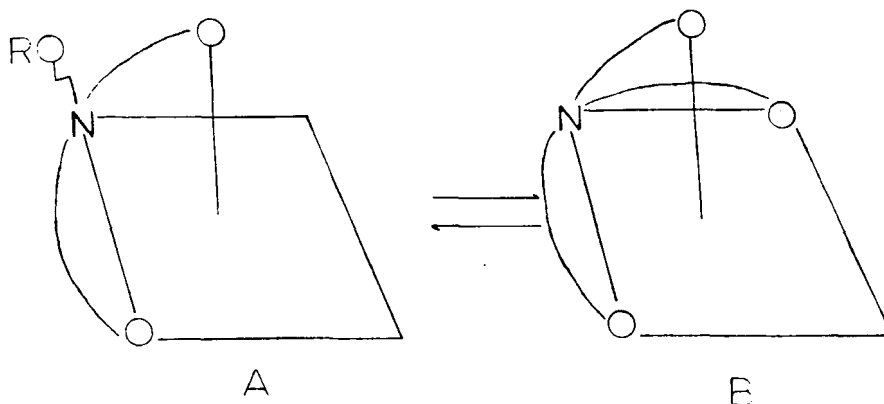

SCHEME I

partial saturation caused by the high H_1 power levels used to obtain acceptable signal to noise ratios. It is not the purpose of this communication to resolve this difficulty, but it does appear to arise frequently. Since the assignment of the 34°C spectrum is ambiguous, Equation 1 was solved for f with the assignment as shown in Table I and also with the assignment of CH_3O and CH_2O reversed. The results are shown in Table II. The assignment of the spectrum chosen is the one which yields the most consistent values of f . The average f value of $0.85 \pm .18$ indicates substantial oxygen coordination. Unfortunately, it is not possible to use the Ni(HEIDA) spectrum to resolve this difficulty as the peak which remains in the spectrum of this compound appears between the two resonances in question.

The experimental error in the determination of f was estimated by assigning an experimental error of ± 2 ppm to the resonance position of broad peaks and peak positions obtained from literature sources and assigning an experimental error of ± 1 ppm to sharp resonance positions determined in this work. In most cases the experimental uncertainty in the values of f is estimated to be about 20%. While this is substantial uncertainty, all of the values of f are large enough that significant oxygen bonding is indicated even for the worst cases.

The equilibrium constant for coordination can then be calculated $K_{\text{eq}} = f/1 - f = 6 \pm 6$. The ΔG calculated for a K_{eq} of 6 at 34°C is -1.1 kcal/mole. Because of the large experimental uncertainty in K_{eq} one must be very careful not to place too much emphasis on this numerical result. Examination of the temperature dependence of the chemical shifts of these protons, however, shows that the Curie law is obeyed. Since a shift in the position of equilibrium would result in a deviation from the Curie law,¹⁵ this observation indicates that the equilibrium constant does not change with temperature, and, hence ΔH is 0 within experimental error. Taking

TABLE II
 f values for Ni(MEIDA) calculated at different spectral assignments

Resonance used	Observed shift ^a	f
NCH_2	-118 ppm	$0.97 \pm .10$
CH_2O^b	-27 ppm	$0.87 \pm .27$
CH_3O^b	-15 ppm	$0.71 \pm .16$
CH_2O^c	-15 ppm	$0.38 \pm .17$
CH_3O^c	-27 ppm	$1.26 \pm .26$

^a 34°C

^bAssignment used in table I

^cAlternative spectral assignment

TABLE III
Spectral Assignments of Cobalt Complexes

Complex ^a	Resonance Position ^b	Assignment
Co(MEIDA)(H_2O) ₂	10	$\text{CH}_3\text{O} + 2\text{CH}_2\text{CO}_2^-$
	25	Impurity
	36	CH_2OH or NCH_2
	46	$2\text{CH}_2\text{CO}_2^-$
	53	NCH_2 or CH_2OH
Co(HEIDA)(H_2O) ₂	8	$2\text{CH}_2\text{CO}_2^-$
	24	Impurity
	37	CH_2OH or NCH_2
	61	$2\text{CH}_2\text{CO}_2^-$
	67	NCH_2 or CH_2OH
Co(SER)(H_2O) ₃ [†]	29	$1\text{CH}_2\text{OH}$
	51	$1\text{CH}_2\text{OH}$
	76	CHCO_2H
Co(AEAE)(H_2O) ₃ [‡]	19	$1\text{CH}_2\text{OH}$
	33	$1\text{CH}_2\text{OH}$
	86	$1\text{NCH}_2\text{CH}_2\text{N}$
	92	$2\text{NCH}_2\text{CH}_2\text{N}$
	109	$1\text{NCH}_2\text{CH}_2\text{N}$
	129	1NCH_2
	137	1NCH_2
	195	Uncertain
Co(BHEEN)(H_2O) ₂ ²⁺	14	$1\text{CH}_2\text{OH}$
	28	$1\text{CH}_2\text{OH}$
	61	Uncertain
	62	Uncertain
	80	Uncertain
	88	Uncertain
	101	Uncertain
	122	Uncertain
	125	Uncertain
	195	Uncertain

^aNumber of waters in structure determined on basis that all ligand coordinating groups are utilized.

^bppm downfield of water at 34°C .

^cPeak location determined at 96°C and extrapolated to 34°C .

the ΔG at 34°C (above) and assuming that ΔH is 0, leads to the conclusion that ΔS for coordination of the oxygen in this case is about +4 eu. A similar analysis of the data for the HEIDA complex yields f values of $0.76 \pm .11$ using the NCH_2 resonance position and $0.73 \pm .22$ when the CH_2O resonance is used. Since the Curie law is obeyed in this case also, the ΔS calculated from the average value of f (0.75), is 2 eu.

The experimental errors and assumptions associated with the above analysis are certainly very large and one must be careful not to attach too much significance to the numerical values. What these calculations do show is that in both of these complexes the oxygen is coordinated a significant fraction of the time (>50%) and that the principle reason why extensive coordination occurs is a gain in entropy. That a gain in entropy is responsible for coordination is not really surprising since the heat of reaction

observed would be the difference between ΔH for coordination of water and ΔH for coordination of an alkyl oxygen. Since one neutral oxygen donor is being replaced by another, relatively little difference in ΔH is expected. It is somewhat surprising that so little difference in coordination ability is seen between CH_3O and HO , however. Previously, it was reported that that replacement of HO by CH_3O results in approximately a two order of magnitude decrease in formation constant.³ The results reported here do not show any significant difference in the coordinating abilities of CH_3O and HO . Considering that the earlier conclusion was based upon a comparison in two different solvents, the effect observed may have been due to solvent differences rather than differences in the inherent coordinating abilities of the two groups.

Coordination to nickel (II) by a non-acetate type oxygen is also observed in the complex $\text{Ni}(\text{SER})(\text{H}_2\text{O})_3^+$. The nickel (II) serine complex, however, does not obey the Curie law. The room temperature peak at -34 ppm shows a slight negative deviation (to greater shifts) while the peaks at -15 ppm and -31 ppm show a slight positive deviation. This deviation from the Curie law is indicative of a slight shift in the amount of oxygen coordination with temperature with the amount of coordination greater at low temperature. The model compound ethanol amine had a similar deviation from Curie law,³ except the NCH_2 resonance obeyed Curie law. In order to determine the amount of time that the oxygen is coordinated a model with 100% OH coordination is necessary. Unfortunately, the obvious model, ethanol amine deviates from Curie law implying less than 100% OH coordination. Therefore, the model compound used for 100% oxygen bonding is ethyl ether diamine ($\text{NH}_2\text{CH}_2\text{CH}_2\text{OCH}_2\text{CH}_2\text{NH}_2$) (38 ppm).⁴ The deviation from the Curie law is assumed to occur because the fraction of time the oxygen is coordinated is a function of temperature. Using the observed average shift of -23 ppm at 34°C and -18 ppm at 96°C yields $f = .57 \pm .18$ at 34°C and $0.52 \pm .21$ at 96°C . Solving for ΔH and ΔS is very tenuous in this case. The values calculated using the f values reported are $\Delta H = .8$ kcal/mole $\Delta S = 2$ eu. Although there is considerable uncertainty in these values, it is safe to assume that ΔH is negative for the coordination of the serine OH and that ΔH values of about 1 kcal/mole are observable by the technique used in this study. Thus, ΔH for those reactions for which zero is reported are considerably less than 1 kcal/mole.

The ligands 2(2-aminoethylamino)ethanol (AEAE)

and *N,N'*-Bis(2-Hydroxyethyl)-ethylenediamine (BHEEN) are ligands which have two nitrogen donors and one and two oxygen donors, respectively. The ligand BHEEN is similar to MEIDA and HEIDA in that it is potentially tetracoordinate, but, because it is a straight chain ligand, the formation of a tetracoordinate species could involve ring strain. Since ΔH for coordination of these oxygens has been very close to zero in all other cases the increase in enthalpy of coordination for the BHEEN is taken as a direct measure of the ring strain involved in the formation of the tetracoordinate species.

Examination of the spectra shown in Figure 3 for the complex $\text{Ni}(\text{AEAE})(\text{H}_2\text{O})_3^{2+}$ once again indicates a substantial amount of oxygen coordination as all protons have large contact shifts. In order to determine the fraction of time the oxygen is coordinated a procedure similar to the one used above is employed. Since this complex obeys the Curie law, the resonances at 96°C were measured and extrapolated to ambient temperature (34°C) to determine the lower temperature peak positions. This was done because the peaks are considerably sharper at the higher temperature. The broadness of the peaks at room temperature and the temperature dependence indicates that the rate of structural interconversion (Scheme II) is only slightly faster than the chemical shift differences ($1.1 \times 10^3 \text{ sec}^{-1}$).

The spectrum of this complex has been assigned by comparison with the spectrum of $\text{Ni}(\text{NEtEN})^{15}$ ($\text{NEtEN} = \text{CH}_3\text{CH}_2\text{NHCH}_2\text{CH}_2\text{NH}_2$) and $\text{Ni}(\text{IDE})^{2+4}$ ($\text{IDE} = \text{HOCH}_2\text{CH}_2\text{NHCH}_2\text{CH}_2\text{OH}$). In this assignment it was assumed that the shifts of the $\text{NCH}_2\text{CH}_2\text{N}$ portion would be essentially the same as that for that portion of NEtEN regardless of whether or not the oxygen was coordinated. The shift of $\text{NCH}_2\text{CH}_2\text{OH}$, and $\text{NCH}_2\text{CH}_2\text{OH}$ were assumed to depend upon the fraction of time that the oxygen is coordinated in the following way:

$$\delta = f(\delta_{\text{IDE}}) + (1 - f)(\delta_{\text{NEtEN}})$$

where

δ_{IDE} = the shift of those protons in the complex $\text{Ni}(\text{IDE})(\text{H}_2\text{O})_3^{2+}$: -29 ppm for CH_2OH , -105 ppm for NCH_2 ⁴

δ_{NEtEN} = the shift of those protons in the complex $\text{Ni}(\text{NEtEN})(\text{H}_2\text{O})_4^{2+}$: -4 for CH_2OH and -76 for NCH_2 ¹⁶

and f = the fraction of time that the oxygen is coordinated.

This analysis, then, provides two equations which can be independently solved for f . Solution for f

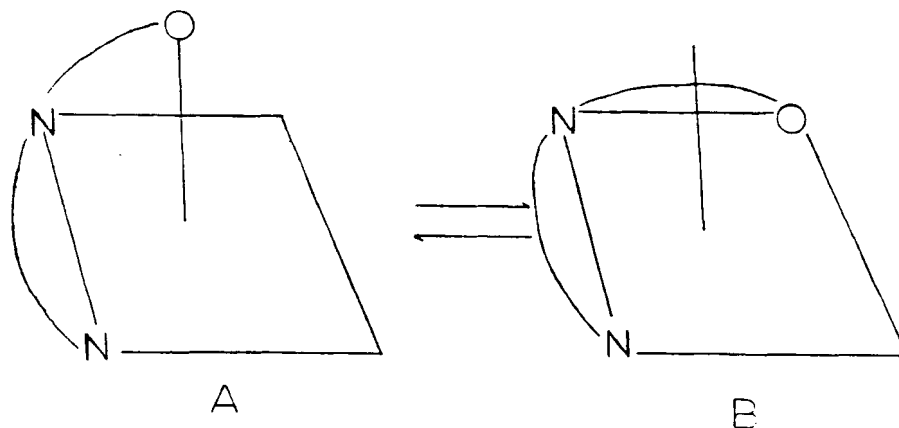

SCHEME II

from the data for CH_2OH yields $f = 0.60 \pm .26$ and the data for NCH_2 yields $f = 0.76 \pm .24$. While this agreement may not seem exceptional, it is comparable to what was obtained for the other ligands and is well within the experimental uncertainty of the measurements. It should be noted that the data for NEtEN were obtained by making measurements from a figure in reference 15. The average of these two values, 0.68, indicates a substantial degree of oxygen coordination. Once again, since Curie law is obeyed, the ΔH for the reaction is zero and ΔS is about 1.5 eu.

Examination of the spectra of $\text{Ni}(\text{BHEEN})$ shows that oxygen coordination occurs in this complex also. However, in this case, Curie law is not followed. Assuming that the deviation from Curie law arises from changes in the amount of oxygen coordination, these data led to the conclusion that $f = 0.62 \pm .25$ at 34°C and $0.70 \pm .42$ at 96°C . These f values yield a ΔH of $+1.4$ kcal/mole and ΔS of $+5.4$ eu. These values of f are averages for each of the two oxygens of BHEEN .

Each oxygen is coordinated approximately 62% of the time at 34°C . Both oxygens are simultaneously coordinated only 24% of the time. In order to calculate the amount of ring strain, the fraction of time both oxygens are coordinated must be determined and the equilibrium constant for coordination of both oxygens calculated. Using the values calculated above the fraction of time that both oxygens are coordinated is found to be 0.24 at 34°C and 0.40 at 96°C . These data lead to $\Delta H = +2.7$ K cal/mole and $\Delta S = +6.6$ eu for coordination of both oxygens. ΔH is assumed to arise from ring strain. It is interesting to note that this amount of heat, 2.7 K cal/

mole, is very nearly the amount that the heat of formation of $\text{Ni}(\text{tetren})(\text{H}_2\text{O})_2^{2+}$ (tetren = $\text{NH}_2\text{CH}_2\text{CH}_2\text{NHCH}_2\text{CH}_2\text{NHCH}_2\text{CH}_2\text{NH}_2$) differs from the heat of formation of $\text{Ni}(\text{NH}_3)_4(\text{H}_2\text{O})_2^{2+}$ (2.1 K cal/mole).¹⁷

Another interesting aspect of the spectral behavior of this complex is that the peaks appear to coalesce at low temperature and separate into well resolved peaks at high temperature. Furthermore, at 96°C 10 peaks are discernable for the 12 non-deuterium exchanged protons. This indicates that, probably, none of the protons are equivalent (accidental overlap being responsible for the apparent equivalence of two pairs of protons) and, hence, the complex must be unsymmetrical.

These two observations can be explained on the basis of the equilibrium shown in Scheme III: because the nitrogens are not inverted in this process, no two protons see identical averaged environments even when the reaction is fast. This scheme is analogous to the situation involved in the facial \rightleftharpoons meridional isomerization of $\text{Ni}(\text{dien})(\text{H}_2\text{O})_3^{3+}$.⁴ At low temperature, the rate of this interchange becomes comparable to the chemical shift differences for each proton in the two forms and the broadening of the resonances observed ensues. Examination of intermediate temperatures shows that this phenomenon is not true coalescence, but is simply a broadening of the resonances as the temperature is lowered. Further cooling to -15°C did not result in the appearance of the unbroadened spectra because of extreme broadening of the resonances. This broadening is probably due to a combination of greater electron relaxation time and greater viscosity of solution (longer correlation time) and is common occurrence in contact shift measure-

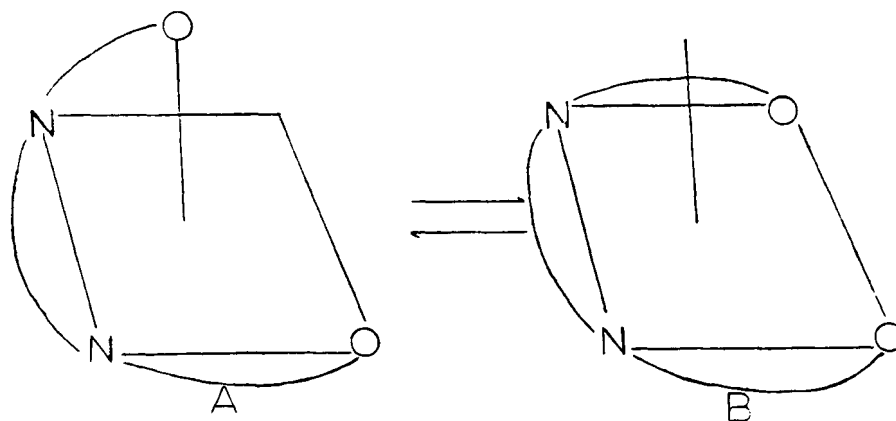

SCHEME III

ments. Thus, it was not possible to observe the spectrum of the complex free from kinetic complications.

It should be noted that if the temperature could be lowered without excessive line broadening, the low temperature ("frozen") spectrum which would consist of a mixture of IIIA and IIIB would have only a maximum of twelve peaks because IIIA and IIIB would have identical spectra. In other words, this is a very unusual type of temperature dependence in which the average spectrum has the same number of peaks as the sum of the two spectra from which it is averaged.

Cobalt (II)

In order to determine if non-acetate oxygen coordination occurs in the cobalt (II) complexes the same two questions must be asked: Namely, how will the spectrum appear if the oxygen coordinates and how will the spectrum appear if the oxygen does not coordinate? The presence of pseudo contact shifts and the complicated dependence of these shifts on the structure of the complex makes the solution of this problem much more complicated than the nickel (II) cases discussed above. For example, Smith and Pratt¹⁸ had reasonably concluded that oxygen coordination occurs in Co(HEIDA) on the basis of spectral differences between 1:1 and 2:1 complexes. While this conclusion seems reasonable and is probably correct, one could argue that it is not necessarily so because the spectral differences observed are quite similar to the differences which are observed between N-methyl IDA and N-ethyl-IDA. That is, the N-alkyl resonances shift from ~ -20 ppm to $\sim +40$ ppm

probably because of conformational preferences of the ethyl group. Thus, one could argue that these spectral differences between 1:1 and 2:1 HEIDA also arise from conformational preference differences and not from differences in oxygen bonding. This argument is counteracted somewhat, however, by the fact that relatively minor spectral differences are observed between Co(NEtIDA) and Co(NEtIDA)₂. If the difference between Co(HEIDA) and Co(HEIDA)₂ was due, for example, to a change in the g-tensor, a similar spectral change might be expected in the NEtIDA case also, but this does not happen.

In order to demonstrate non-acetate oxygen coordination to cobalt(II) in an unambiguous fashion we examine the spectra of the complexes reported here. The spectra for all complexes studied are reported in Table III. The HEIDA and MEIDA complexes are certainly consistent with oxygen coordination. In fact, because of the great distance an uncoordinated CH₃O group would be from the cobalt(II), it is reasonable to expect that both the Fermi contact and dipolar shifts would be very small and, hence, the methyl would have a very small shift. The ~ 10 ppm shift is indicative of oxygen coordination but is not so large that there is no doubt. One should also note that the kinetic complications which were observed in both Ni(HEIDA) and Ni(MEIDA) are not observed: the kinetic process either does not occur in this case or is rapid at 34°C. In view of the rapid racemization of Co(II)EDTA¹⁹ and the discussion below, the later interpretation seems most reasonable.

In order to unambiguously demonstrate the coordination of oxygen to cobalt (II) in aqueous

solution it is necessary to examine a situation in which oxygen coordination produces a change other than a simple shift in resonance position. In this regard we examine the complex formed between cobalt (II) and serine. Serine contains three non-exchangeable protons. If the OH of serine were not coordinated, the $-\text{CH}_2\text{OH}$ alkyl group would occupy an equatorial environment and, *via* free rotation around the single bonds, the two protons on this fragment would appear as a single average peak. If, however, the oxygen is coordinated, these two protons would occupy non-equivalent positions and would appear as separate resonances. Examination of Table 3 shows that three well-separated resonances are observed leading to the conclusion that coordination of the alcoholic oxygen does occur. This conclusion is reinforced by the fact that all these resonances appear downfield from water while uncoordinated alkyl groups often appear upfield of water.¹⁸ Unfortunately it is not possible to obtain a shift value which one can assign to oxygen coordinated species for two reasons: first, attempts to obtain the spectra of simple ligand complexes such as ethanol amine and methoxyethylamine, which were so important for the nickel study, were unsuccessful because of rapid precipitation of cobalt hydroxide when the ligand and metal are mixed and second, the shifts of the simple ligands may not be the same because of changes in the g-tensor when other coordinating groups are added to the ligand. Thus, while these data seem to clearly indicate coordination to the cobalt, they do not allow a quantitative assessment of the amount of time that they are coordinated.

In view of the fact that cobalt(II) complexes may not obey the Curie law even in the absence of temperature dependent structural changes,²⁰ it is also not possible to utilize temperature variation to determine the sign of ΔH for these complexes. Thus, while one can tell that oxygen coordination does occur it is not reasonable to estimate the extent of this coordination nor can the sign of ΔH for this coordination be determined.

Clearly, if any significant amount of uncoordinated OH exists in $\text{Co}(\text{SER})(\text{H}_2\text{O})_3^{2+}$ it must be in rapid equilibrium with coordinated OH as only 3 peaks are observed. Cooling to -10°C did not change the spectrum in any way, except to move all the peaks to higher fields (smaller shifts). We have also observed that the complex is in rapid equilibrium with uncoordinated ligand. Figure 4 shows the spectrum obtained when a large (5-fold) excess of serine is added to cobalt(II). The three peak pattern shifts to higher fields by an amount proportional to the

amount of excess free ligand and no uncoordinated ligand peak is observed. This clearly indicates a rapid equilibrium between coordinated and uncoordinated ligand similar to the exchange between $\text{Co}(\text{IDA})$ and $\text{Co}(\text{IDA})_2$ previously observed.¹⁹ The rate of this reaction is, however, surprising. Using the chemical shift of the most shifted resonance (76 ppm) as a lower limit for the rate of exchange yields a maximum life time for a coordinated species of $<3.5 \times 10^{-5}$ sec. at probe ambient temperature. This life time is the same order of magnitude as the relaxation time for exchange of ammonia with cobalt(II) reported by Rorabacher.²¹ This observation would seem to indicate that the rate determining step in the exchange reaction is loss of coordinated water. Since this ligand does not fulfill the requirements of the internal conjugate base mechanism,²¹ the fast exchange cannot be explained on that basis. It is, therefore, concluded that the complex $\text{Co}(\text{SER})_2$ exists as $\text{Co}(\text{SER})_2(\text{H}_2\text{O})$ with the water in the coordination site which OH would occupy if it was coordinated. This indicates that each OH is coordinated approximately 50% of the time. A similar study of cobalt (II) aspartic acid shows that exchange is slow on the nmr time scale in this case.²² This observation is consistent with the greater coordinating ability of carboxylate. It should be noted that the data in Figure 4 show that the only difference between $\text{Co}(\text{SER})(\text{H}_2\text{O})_3^{2+}$ and $\text{Co}(\text{SER})_2$ is a slight shift of the CH_2OH resonances but essentially no shift of the CHCO_2H resonance. This shift is a manifestation of the greater amount of time that the OH is uncoordinated in the bis complex and indicates that little or no change in the pseudo contact shift occurs upon coordination of the second ligand.

The room temperature spectra of $\text{Co}(\text{AEAE})(\text{H}_2\text{O})_3^{2+}$ and $\text{Co}(\text{BHEEN})(\text{H}_2\text{O})_2^{2+}$, Figure 5, are consistent with a significant fraction of oxygen coordination since, if oxygen coordination did not occur, the CH_2OH protons would be expected to be a single averaged peak brought about by free rotation. Two differences can be seen, however, between the cobalt and nickel complexes. First of all, at room temperature, the resonances of the cobalt complex are sharp indicating either a rigid conformation or rapid interconversion of $\text{III A} \rightleftharpoons \text{III B}$. At high temperature, the pattern of peaks coalesce into three peaks. The greater number of peaks observed at 34°C for the BHEEN complex demonstrates that an unsymmetrical structure exists in solution for this complex similar to that observed in the nickel case. At high temperature, however, the peaks are coalesced. In

order to cause coalescence of these peaks, the nitrogens must be inverted and, hence, the cobalt-nitrogen bond must be broken. The life time for the cobalt nitrogen bond estimated from the chemical shift difference observed at room temperature and the coalescence temperature is approximately 2×10^{-4} sec at 60°C. This lifetime is an order of magnitude longer than the lifetime observed in the serine study but is still quite short.

Thus, it is apparent that a substantial amount of coordination occurs in aqueous solution and, within the constraints of the assumptions made, the fraction of time that these oxygens are coordinated can be estimated for nickel (II) complexes but can not be reliably estimated for the cobalt (II) complexes. It is unfortunate that it is not possible to make quantitative measurements of the cobalt complexes but, in view of the large chemical shift differences observed for the CH₂OH protons of Co(SER)(H₂O)₃²⁺ and the considerable shift of CH₃O in Co(MEIDA)-(H₂O)₂, it would seem that the amount of coordination is substantial. The assumptions which must be made to make numerical estimates in this case, however, do not seem justified.

ACKNOWLEDGEMENT

Support of the National Institutes of Health Grant GM 20645 and a Merck Company Foundation Faculty Development Grant are gratefully acknowledged.

REFERENCES

1. L. Pratt and B. B. Smith, *Trans. Faraday Soc.*, 915 (1969).
2. L. R. Nylander and S. F. Pavkovic, *Inorg. Chem.*, 9, 1959 (1970).
3. R. F. Evilia and C. N. Reilley, *J. Coord. Chem.*, 3, 7 (1973).
4. R. F. Evilia, D. C. Young and C. N. Reilley, *J. Coord. Chem.*, 3, 17 (1973).
5. S. Yamada, Y. Kuge and K. Yamanouchi, *Bul. Chem. Soc. Jpn.*, 40, 1864 (1967).
6. A. Chakrovorty, J. P. Fennessey and R. H. Holm, *Inorg. Chem.*, 4, 26 (1965).
7. S. Yamada, E. Ohno, Y. Kuge, A. Takenchi, K. Yamanouchi and K. Iwasaki, *Coord. Chem. Rev.*, 3, 247 (1968).
8. A. A. Diamantis, H. Weigold and B. C. West, *J. Chem. Soc. A*, 1281 (1967).
9. M. Ciampolini and N. Nardi, *Inorg. Chem.*, 6, 445 (1967).
10. F. P. Dwyer, N. S. Gill, E. C. Gyrfas and F. Lions, *J. Am. Chem. Soc.*, 75, 1526 (1953).
11. S. Yamada, K. Yamanouchi, W. Mori and M. Kishita, *Bull. Chem. Soc. Jpn.*, 49, 2111 (1976).
12. D. S. Everhart and R. F. Evilia, *Inorg. Chem.*, 14, 2755 (1975).
13. R. Smith, J. L. Bullock, F. C. Bersworth and A. E. Martell, *J. Org. Chem.*, 14, 355 (1949).
14. Data from reference 1 extrapolated to 34°C and changed to water reference.
15. F. F.-L. Ho and C. N. Reilley, *Anal. Chem.*, 41, 1835 (1969).
16. Average Measured from Figure 1 reference 15, corrected to water reference.
17. D. L. Wright, J. H. Holloway and C. N. Reilley, *Anal. Chem.*, 37, 884 (1965).
18. L. Pratt and B. B. Smith, *Trans. Faraday Soc.*, 1703 (1969).
19. D. S. Everhart and R. F. Evilia, *Inorg. Chem.*, 16, 120 (1977).
20. G. N. LaMar and G. R. VanHecke, *J. Am. Chem. Soc.*, 92, 3021 (1970).
21. D. B. Rorabacher, *Inorg. Chem.*, 5, 1891 (1966).
22. D. S. Everhart and R. F. Evilia, Unpublished results.